



supplement | Additional products for
CF-IRMS

to be used in conjunction with our main
CHNOS analysis catalogue

Ordering Information

We are happy to accept orders by any of the following methods:

Phone: +44 (0)1837 54446
Fax: +44 (0)1837 54544
E-mail: info@microanalysis.co.uk
Online: www.elementalmicroanalysis.com
Mail: Elemental Microanalysis Ltd
1 Hameldown Road
Okehampton Business Park
Okehampton
Devon EX20 1UB
United Kingdom

We can invoice you in Sterling, Euro or US Dollar, and accept Visa or Mastercard payments; account facilities are readily available for regular customers, please enquire.

Shipping Worldwide

We regularly ship directly to customers in all parts of the world, and our staff are highly experienced in shipping dangerous goods. Local dealers are available in many countries: contact us for details.



www.elementalmicroanalysis.com

Available locally from:

Literature Available from Elemental Microanalysis

This CF-IRMS brochure is intended for use as a supplement to our main Micro CHNOS catalogue. A range of other catalogues, product sheets and other literature is also available:

Catalogues

Our catalogues cover the following areas of elemental analysis:

- Micro CHNOS
- IRMS Supplement
- Inorganic
- Organic Carbon/Sulphur
- Macro CN/CHN/CNS/N-protein
- Nitrogen/Protein
- Capsules
- Laboratory Analysis Service

Our catalogues are also available to download from the website.



Product Sheets

Product sheets are available for every instrument we support. These cover all the common day-to-day items required to run your instrument.

A complete list of all instruments we support can be found on p25–26 of this catalogue.



Contract Analysis Service

We also offer a contract analysis service for a variety of (mainly) organic compounds. Full details are in the brochure shown, or at www.elementallab.co.uk.

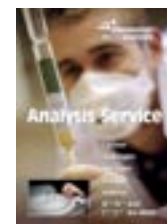

All printed literature is available using the request form on p25–26 of this catalogue, and catalogues can be downloaded from our website.

Contents

- 4 Introduction
- 6 Consumables
- 7 Glassy carbon and ceramic tubes
- 8 Quartz/glass combustion, reaction and scrubbing tubes
- 9 Crucibles, inserts and lances
- 10 Prepacked tubes
- 11 O-rings and seals
 - Separation columns
 - Parts and accessories
- 12 Consumables kits
 - Equilibration reagents and sundries
 - Nafion[®] dryers
- 13 Preparation system vials, seals and caps
- 14 Reference materials
- 15 Configuration guides
- 20 Cross references
- 25-26 Literature request form

Introduction

About the Company

Elemental Microanalysis has grown from small beginnings over 40 years ago as a micro-analytical laboratory to its current form as a leading manufacturer and supplier of consumables, supplies and other products for elemental analysers. We operate from our purpose-built factory, warehouse and laboratory complex in Devon, UK.



You learn a lot in 40 years – a lot about your products – how to make them and how to use them, a lot about your customers and their needs. We have been developing, refining and using products for elemental analysis since 1976 and have a unique in-depth knowledge of instruments from all manufacturers.

These days we offer the world's largest range of products for elemental analysers, sending our products to customers across the globe. We take

great care with the quality of our products. The vast majority are manufactured in-house by our trained technicians within our ISO 9001:2015 accredited quality system. But we don't just make the products – we use them every day in our own analytical laboratory, giving us constant feedback on their performance. We do not compromise on quality and don't expect you to either. Our total satisfaction guarantee backs up our commitment to our product quality.

'Price is what you pay, value is what you get'.

As the leading independent supplier of elemental analysis consumables we can offer substantial savings in comparison to the prices charged by the original supplier of your instrument. But we know that you need more from a supplier than simply low prices. You need to buy with the confidence that your analysis will not be compromised by poor quality consumables and the knowledge that your supplier has all the resources to provide the full range of support that you expect.

We will always treat our customers with honesty and integrity. If we do make a mistake we don't try to hide it – we recognise it and put it right.

We won't sell you short measure and we won't mislead you in any way. Our business is built on long-term relationships, as our customers will testify – many have been with us for more than 30 years.





‘price is what you pay –
value is what you get’

Guaranteed quality

Our company’s quality system is certified to ISO 9001:2015 by LRQA, we have an ISO/IEC 17025:2017 UKAS accredited Testing Laboratory, and we are an ISO/IEC 17034:2016 UKAS accredited Reference Material Producer. Our confidence in our products allows us to offer you a total satisfaction guarantee: if our product does not perform at least as well as the brand of product you usually use, you can return it for a full refund.



Try our products – free of charge!

Try before you buy – we have sample packs available for most elemental analysers on the market. Just let us know the instrument you have and we will send you a trial quantity of 3–4 different consumables to try – free and with no obligation. Offer limited to one per customer.

Sales service

Our friendly sales staff will ensure that your order is despatched promptly and correctly. They can tell you about our stock levels, prices, shipping arrangements, or answer any other queries you may have.

Most orders are despatched within 24 hours of receipt. Rush orders receive special attention and are processed immediately. If you have an urgent problem or need priority despatch, please let us know.



Technical service

In this catalogue we have tried to provide the most accurate and complete information possible about our ever-expanding range. We realise, however, that you may require additional technical information.

For this reason we have technical specialists on hand to answer your questions and advise you on selecting the products best suited to your needs. We can also supply samples, and even develop new products for your particular application.

Design changes

We are constantly working on improving our products and these improvements may mean that some products differ from the descriptions in this catalogue. Our technical staff are happy to discuss any improvements made, and the resultant benefits. Check the website and join our mailing list to keep up-to-date with the latest products and developments.

Consumables CF-IRMS analysis

Cat No	Description	Pack
Reagents		
B1158	1% Platinum/ 1% Nickel Oxide on Copper Oxide Granules, Isotope Catalyst 0.2 to 0.5mm	5g
B1149	1% Platinum/ 1% Nickel Oxide on Copper Oxide Wires, Isotope Catalyst	5g
B1159	3% Platinum/ 1% Nickel Oxide on Copper Oxide Granules, Isotope Catalyst 0.2 to 0.5mm	5g
B1151	3% Platinum/ 1% Nickel Oxide on Copper Oxide Wires, Isotope Catalyst	5g
B1451	Chrome Catalyst 200µm	25g
B1450	Chrome Catalyst 200µm	100g
B1108	Copper Granules Fine Reduced 0.05 to 0.2mm	100g
B1051	Copper Oxide Granular Isotope Grade 0.1 to 0.5mm	50g
B1071	Copper Oxide Granules Silvered Isotope Grade 0.1 to 0.5mm	50g
B1080	Copper Oxide Wires Isotope Grade 4 x 0.5mm	50g
B1070	Copper Oxide Wires Silvered Isotope Grade 4 x 0.5mm	50g
C7003	Glassy Carbon Chips 2-3mm	25g
C7008	Glassy Carbon Chips 2-3mm	50g
C7006	Glassy Carbon Chips 2-3mm	100g
C7002	Glassy Carbon Chips 3-4mm	25g
C7015	Glassy Carbon Chips 3-4mm	50g
C7021	Glassy Carbon Chips 3-4mm	80g
B1065	High Purity Carbon Granular 0.2 to 0.5mm	1g
B1130	Nickel Oxide Granular 0.2 to 0.5mm	25g
B1086	Nickelised Carbon 30% Ni Granular 0.3 to 0.85mm	5g
B1088	Nickelised Carbon 30% Ni Granular 0.85 to 1.7mm	5g
B1087	Nickelised Carbon 40% Ni Granular 0.3 to 0.85mm	5g
B1106	Nickelised Carbon 40% Ni Granular 0.85 to 1.7mm	5g
B1181	Nickelised Carbon 50% Ni Granular 0.3 to 0.85mm	5g
B1182	Nickelised Carbon 50% Ni Granular 0.85 to 1.7mm	5g
B1096	Platinised Alumina 10% Pt Granular Isotope Grade 0.2 to 0.5mm	2g
B1097	Platinised Alumina 20% Pt Granular Isotope Grade 0.2 to 0.5mm	2g
B1005	Platinised Carbon 10% Pt Granular 0.2 to 0.85mm	5g
B1095	Platinised Carbon 20% Pt Granular 0.2 to 0.85mm	5g
B1030	Platinised Copper Oxide 10% Pt Isotope Grade Granular 0.2 to 0.5mm	2g
B1050	Platinised Copper Oxide 20% Pt Isotope Grade Granular 0.2 to 0.5mm	2g
Wires		
D9101	Copper Wire 0.125mm Diameter x 10m	10m
B1156	Copper Wire 0.1mm High Purity Sealed Ampoule 12 x 300mm	300mm
D9102	Nickel Wire 0.125mm Diameter x 10m	10m
D9100	Platinum Wire 0.125 x 1m	1m
Wools		
B1007	Nickel Wool Fine Wire	2g
B1017	Silica (Quartz) Wool Very Fine	5g
B1208	Silica (Quartz) Wool Very Fine	10g
B1276	Silica (Quartz) Wool Very Fine	15g
B1102	Silica (Quartz) Wool Very Fine	50g
B1261	Silver Wool Very Fine Wire Unreeled 89 sqcm/g	2g
B1119	Silver Wool Very Fine Wire Unreeled 89 sqcm/g	10g

Isotope catalyst 0.2 to 0.5mm, 5g
B1158



Chrome catalyst 100g
B1450



Glassy carbon chips 3-4mm, 25g
C7002



Nickelised carbon
50% Ni granular
0.3 to 0.85mm, 5g
B1181

For our range of isotope reference materials, see page 14.

**Do you want to find a product using the manufacturer part number?
— Use the cross reference lists, beginning on page 20.**

Cat No	Description	OEM part
C1106	Ceramic Tube Pyrocube	23.00-1021
C7017	Glassy Carbon Tube Pyrocube	23.00-1020
C1110	Furnace reaction tube ceramic GVI	
C1113	Furnace reaction tube ceramic 1.5 x 0.5 x 320mm	
C1115	Furnace reaction tube quartz 630mm x 6mm x 0.7mm	
C1116	Furnace reaction tube quartz 6mm od 0.5mm id x 610mm	

Cat No	Description	OEM part
C1103	Ceramic Tube HT-O	468110
C7004	Glassy Carbon Tube	46860100

Cat No	Description	OEM part
C1102	Ceramic Tube for Eurovector pack of 2	E12507
C7004	Glassy Carbon Tube Eurovector	E12529

Cat No	Description	OEM part
C1077	Ceramic Tube 1.55mm x 0.6mm x 300mm Europa Orchid	SC0676
C1103	Ceramic Tube	SC0694
C1112	Furnace reaction tube ceramic Europa/PDZ	SC0091
C1117	Ceramic tube 330 x 1.6 x 0.5	SC2366

Cat No	Description	OEM part
C1101	Ceramic Tube for TC/EA	1121320
C1111	Furnace reaction tube ceramic Thermo	
C7001	Glassy Carbon Tube Thermo-Finnigan TC/EA	1121310
C7005	Glassy Carbon Tube Closed One End With 2mm Hole TC/EA	
C7007	Glassy Carbon Tube for use with E4405 12x9x453mm	
C7009	Glassy Carbon Tube Closed One End With 2mm Hole for use with E4405 12x9x420 mm	

Key

Products are colour coded according to the IRMS technique they are used in, as follows:

- High temperature
- O/H pyrolysis and reduction
- CN-IRMS, S-IRMS, CNS-IRMS
- GC combustion/pyrolysis

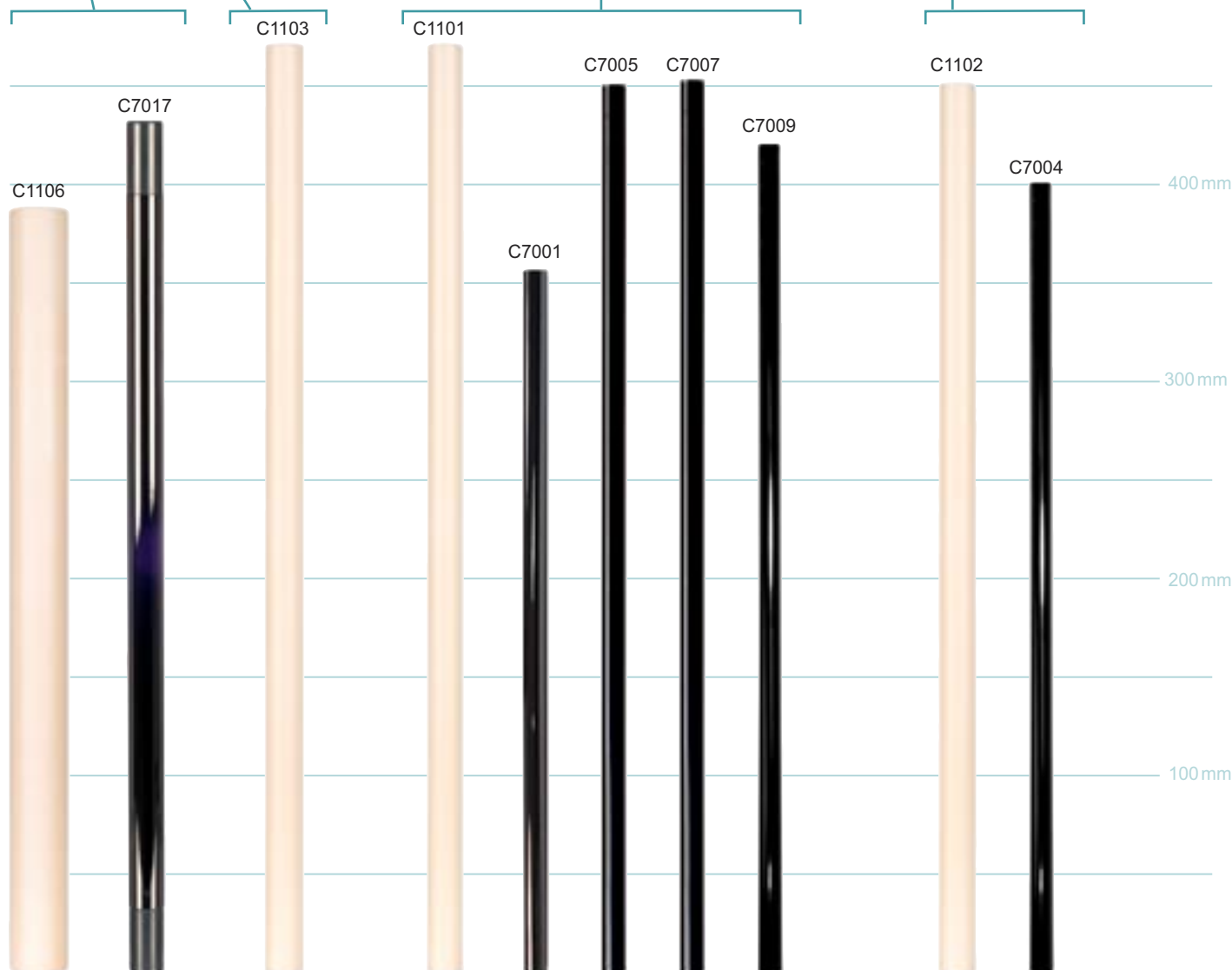

Quartz/glass comb/reaction/scrubbing tubes

Elementar	Cat No	Description	OEM part
	C3050	Reduction Tube Pyrocube	23.00-1149
	C3051	Combustion Tube Pyrocube	23.00-1150

Europa/Sercon	Cat No	Description	OEM part
	C1030	Reduction Tube Transparent Silica	C1001014
	C1032	Scrubber Tube Borosilicate Glass	C1001015
	C1039	Reaction Tube Transparent Heavy Wall Silica	SC0012
	C1040	Reaction Tube Transparent Silica	C1001012
	C1063	Scrubbing Tube Borosilicate	E1002687
	C1075	Reduction Tube Quartz	SC0674
	C1076	Oxidation Tube	SC0675

Eurovector	Cat No	Description	OEM part
	C1056	Reaction Tube Transparent silica	E12512

Thermo	Cat No	Description	OEM part
	C1104	Thermo Precon Scrubber	1068230
	E6101	Small trap with o-rings, threaded caps and fitting (to take 2mm tubing nuts)	28113102

Key

Products are colour coded according to the IRMS technique they are used in, as follows:

- High temperature
- O/H pyrolysis and reduction
- CN-IRMS, S-IRMS, CNS-IRMS
- GC combustion/pyrolysis

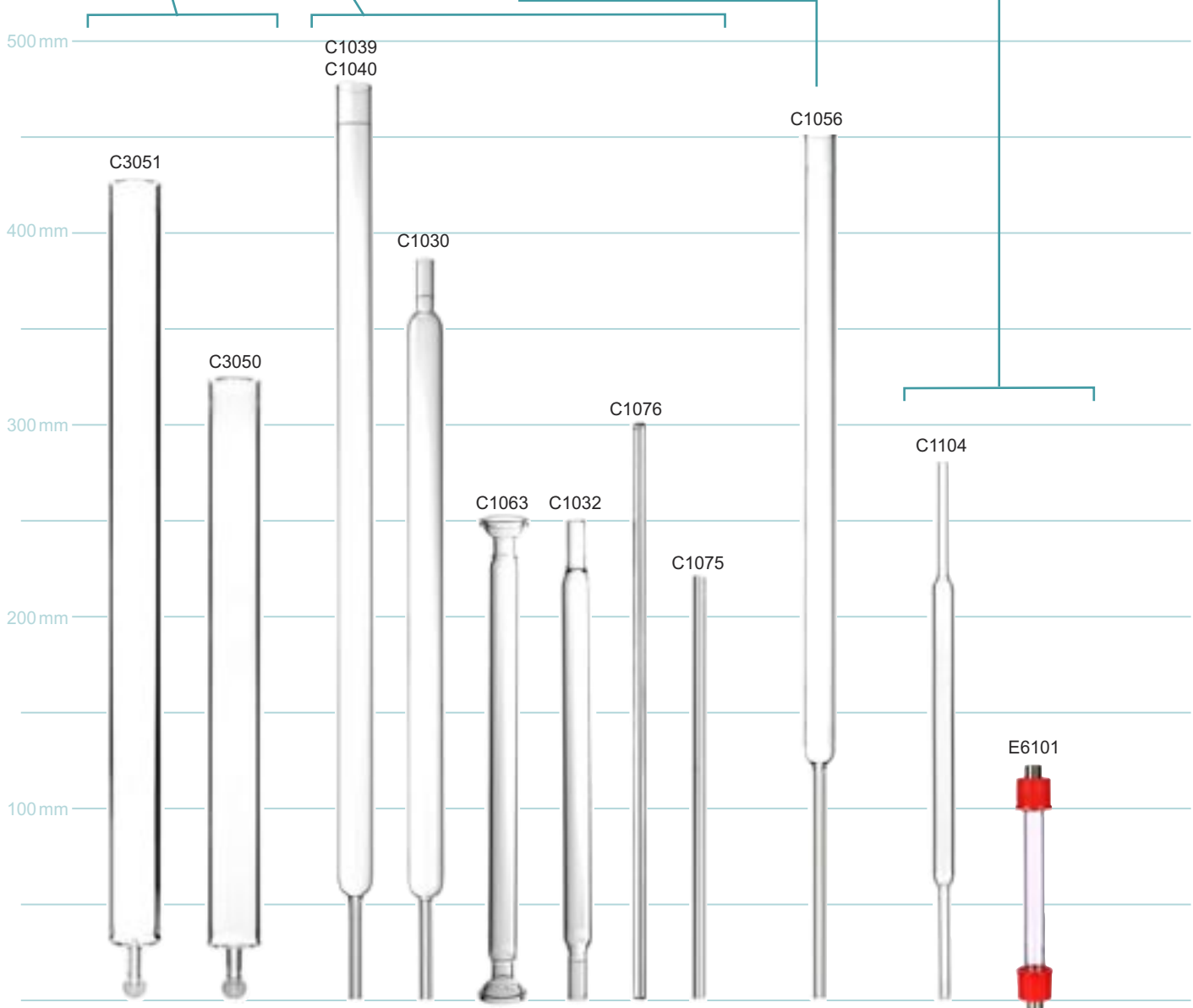

Key

Products are colour coded according to the IRMS technique they are used in, as follows:

- High temperature
- O/H pyrolysis and reduction
- CN-IRMS, S-IRMS, CNS-IRMS
- GC combustion/pyrolysis

Cat No	Description	OEM part
C7012	Graphite Crucible for TC/EA	1117332
C7013	Large Graphite Crucible for TC/EA 5 to 5.1mm wide	SC2388
C7014	Extra Large Graphite Crucible for 9mm id Glassy carbon tubes 5.9mm wide	SC2389
C7019	Hexagonal graphite crucible for TC/EA for use in 7mm ID glassy carbon tubes	
C7020	Octagonal graphite crucible for TC/EA for use in 9mm ID glassy carbon tubes	

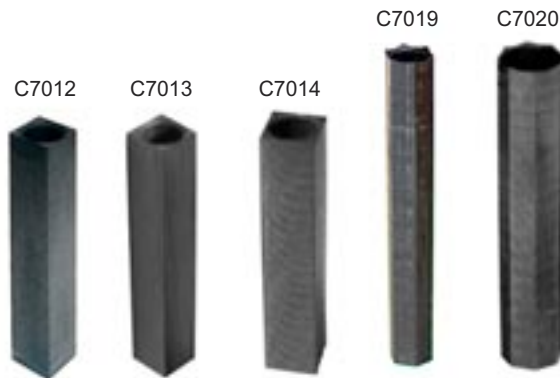

Cat No	Description	OEM part
C1050	Sleeve Insert Open Both Ends Transparent Silica 15 x 180mm Europa	C1001048/SC0011
C1094	Sleeve Insert Open Both Ends Transparent Silica 15 x 220mm Europa	SC0687
C2030	Sleeve Insert Transparent Silica NA1500(1)	SC0729
C3028	Oxygen lance 90mm	05 002 321
C3029	Support Tube 175mm Pyrocube	
C3052	Support rod reduction tube 175mm	23.00-1148
C3053	support rod, reduction tube 65mm	11.00-1364/4
C3057	support rod reduction tube 110mm	15.40-1002
C3061	Ash crucible graphite	23.00-1189
C7018	Ash Finger - High Temperature Pyrocube	15.00-1189
C7010	TC/EA Graphite Tube	1121351
C7011	H2O Graphite Tube for TC/EA	1132080
C7022	Cone for Glassy Carbon Reactor (1pcs) Eurovector	C10-181

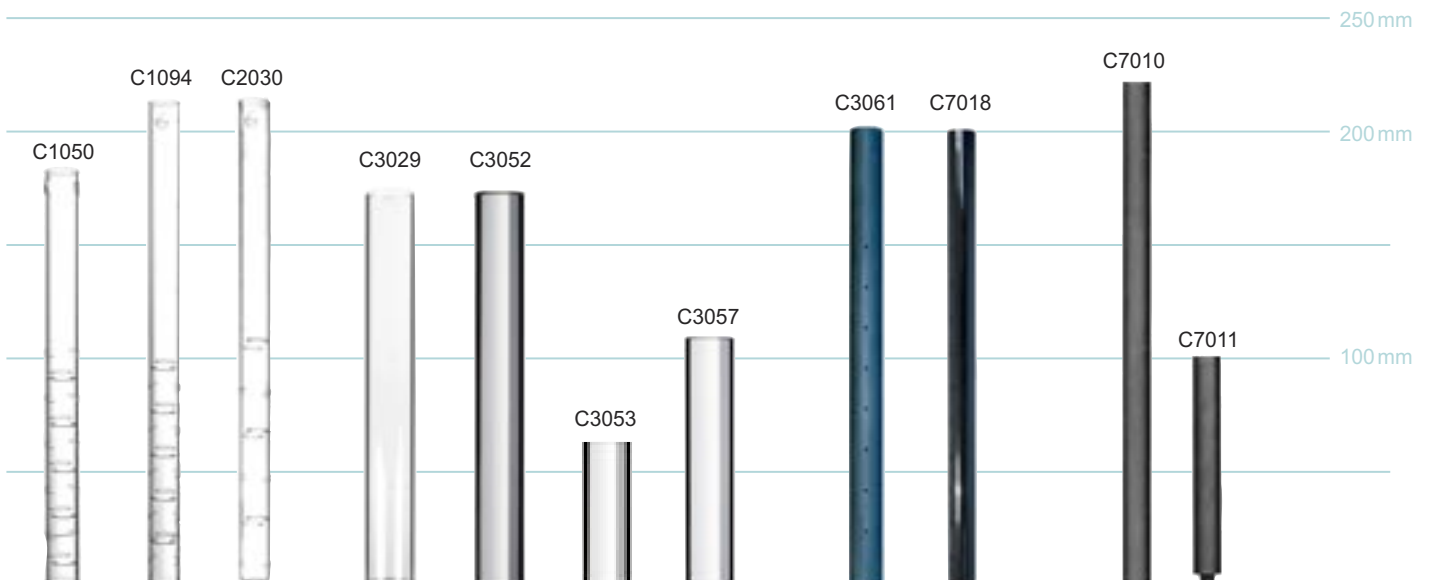

Prepacked tubes

CF-IRMS analysis

	Cat No	Description	OEM part
Elementar	X1504	Prepacked GC Reaction Tube 630x1/4x0.7mm Quartz Copper Oxide wires + 1%Pt + 1%NiO	
Europa/Sercon	X1200	Prepacked Reaction Tube Europa Includes C1050 Quartz Liner Transparent	SC2147
	X1201	Prepacked Reaction Tube Europa Transparent heavy wall Includes C1050 Quartz Liner	SC2149
	X1202	Prepacked Reduction Tube Roboprep	SC2150
	X1203	Prepacked Reduction Tube Europa	SC2151
	X1204	Prepacked Reduction Tube Europa Transparent Heavy wall	SC2152
	X1205	Prepacked Reaction/Reduction Tube Sulphur - Europa - Transparent	SC2153
	X1207	Prepacked Oxygen Pyrolysis Tube Europa Transparent Silica	SC2155
	X1209	Packed Hydrogen Pyrolysis Tube Europa Transparent Silica	SC2157
	X1501	Prepacked GC Reaction Tube 400x1.6x0.8mm Ceramic Copper Wire	SC2177
	X1502	Prepacked GC Reaction Tube 400x1.6x0.8mm Ceramic Copper/Platinum Wire	SC2178
	X1503	Prepacked GC Reaction Tube 400x1.6x0.8mm Ceramic Nickel Wire	SC2179
	X1505	Prepacked GC oxidation reactor tube 320x1.5x0.5mm Ceramic Copper/Platinum/Nickel Wire	1040920
	X1506	Prepacked GC reduction reactor tube 320x1.5x0.5mm Ceramic Copper Wire	1040820
	X1507	Prepacked GC Reaction Tube 400x1.6x0.8mm Ceramic Copper/Nickel/Platinum Wires	
Thermo	X1104	Prepacked Thermo Precon Scrubber	
	X1505	Prepacked GC oxidation reactor tube 320x1.5x0.5mm Ceramic Copper/Platinum/Nickel Wire	1040920
	X1507	Prepacked GC Reaction Tube 400x1.6x0.8mm Ceramic Copper/Nickel/Platinum Wires	
	X1500	Prepacked GC Reaction Tube 600x3x0.5mm Ceramic Copper/Platinum Wire	SC2176
	X1506	Prepacked GC reduction reactor tube 320x1.5x0.5mm Ceramic Copper Wire	1040820
	X1172	Prepacked Ox/Red Reactor CNS for Flash HT Plus (Argon sealed)	46802021
	X7021	Prepacked reactor Flash HT (ceramic and glassy carbon)	
	X7020	Prepacked TC/EA Tube (ceramic and glassy carbon)	1127500

Key

Products are colour coded according to the IRMS technique they are used in, as follows:

- High temperature
- O/H pyrolysis and reduction
- CN-IRMS, S-IRMS, CNS-IRMS
- GC combustion/pyrolysis





Cat No	Description	Pack	OEM part
E1001	O Ring Viton Rubber	10	29030331
E1004	O Ring Nitrile Rubber	10	29030042
E1042	Seal Viton Rubber Chamfered Square Profile	5	29030042
E1420	O Ring Europa	1	E1005669
E1421	O Ring Europa	1	E1002684
E1504	O-ring EVR for reactor 18mm od	1	E13536
E1506	O-ring for ceramic reactor 17mm	1	E13538
E1507	O-ring EVR for bottom quick fit 17mm	1	E13539
E1508	O-ring viton bottom quick fit 6mm	1	E13540
E6053	O Ring TC/EA	1	1121120
E6054	O Ring pack of 2 for E4405	2	29000063



Separation columns



Cat No	Description	OEM part
E3001	Separation Column Oxygen 1m stainless steel	26007900
E3009	Separation Column Oxygen 1.5m stainless steel	
E3011	NC separation column for IRMS	26007931
E3030	Separation Column Oxygen 1m ANCA-SL/GSL	SC2010
E3031	Separation Column NC 0.5m stainless steel Europa GSL/Integra	E1004907/SC2011
E3032	Separation Column Sulphur 0.6m stainless steel Europa GSL/Integra	SC2012
E3033	Separation Column NC 0.5m stainless steel Europa Roboprep	SC2013
E3035	GC Column TC/EA 0.6m 1/4 Stainless Steel	1121030
E3036	Separation column O/H 1.5m stainless steel	E11521
E3037	Eurovector high resolution column (0.7m) for GC separation of C/N	E11528-IG
E3042	Modified GC column TC/EA 1.5m long	

Modified lower fitting for improved analysis of waters

The adapter (E4405) channels the helium flow up between the ceramic outer and down through the centre of the glassy carbon tube, ensuring all water vapour is swept down into the reactive zone. Use of this fitting requires a different length glassy carbon inner from standard (C7007).



Parts and accessories

Cat No	Description	OEM part
E4405	Bottom feed adapter TC/EA with O-rings	
E4406	TC/EA Furnace Element	
E4407	TC/EA Furnace Repair - Does not include thermocouple replacement	
E4408	TC/EA Furnace Assembly	
F5170	Capillary SS 1/16 x 0.8 mm, 2m	605470



Consumables kits

CF-IRMS analysis

Consumable kits provide every consumable you should need for the day-to-day running of your instrument, for the specified type of analysis. Please check our website for the contents of each kit.

	Cat No	Description	OEM part
Eurovector	X3250	Consumable Kit Eurovector EA - CN 1000 analyses	6063056
	X3251	Consumable Kit Eurovector EA - O/H solid samples (high temperature)	6062979
	X3252	Consumable Kit Eurovector EA - Sulphur 1000 analysis	6062974
	X3253	Consumable Kit Eurovector EA - Hydrogen spares for liquid samples (low temperature)	6062977
	X3254	Consumable Kit Eurovector EA - Oxygen spares for liquid samples	6062978
		Thermo Flash 2000 IRMS	
	X1115	NC Kit, Flash IRMS, 1000 analyses	19003770/1293150
	X1137	Spare parts/consumables, Flash 2000 HT & EA IsoLink CN/OH, OH analysis (3000 analyses)	1185471
	X1139	Kit for 8000 analyses Flash for IRMS / HT NCS analysis	
		Thermo Flash HT	
Thermo	X1138	Consumables Flash HT and TC/EA, OH-Analysis (1000 Analyses)	1290340
	X1139	Kit for 8000 analyses Flash for IRMS / HT NCS analysis	
	X7008	Reactor kit Flash HT	1197480
		Thermo TC/EA	
	X1136	Spare Parts/Consumables TC/EA, OH Analysis (3000 Analyses)	1136820
	X1138	Consumables Flash HT and TC/EA, OH-Analysis (1000 Analyses)	1290340
	X7007	Reactor Kit TC/EA	1141050

Equilibrium reagents and sundries

Cat No	Description	Pack
B1452	Platinum Catalyst Sticks for HD Equilibration	50 Sticks
B1453	5% Pt on Alumina -325mesh Powder	10g
E2800	Tapered Glass Insert for use with B1453 in equilibrium (exchange) reactions	1000

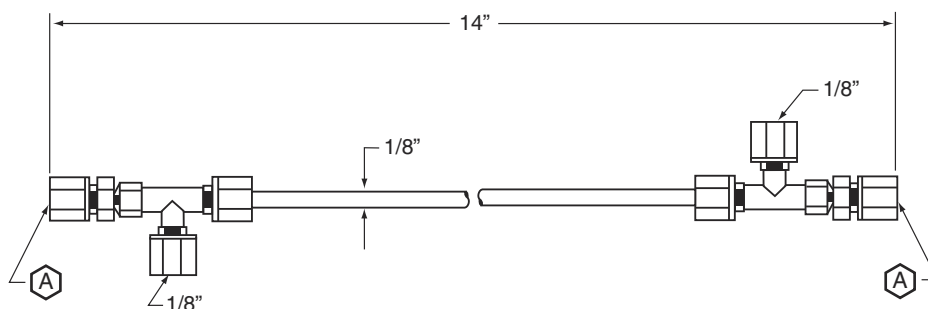

Nafion® dryers

Nafion® water removal dryers can be supplied as complete units or replacement inner elements. Dryers and elements are supplied with 0.05" OD, 0.04" ID Nafion® tubing.



Cat No	Description
	Complete dryer
E2810	Nafion Dryer Stainless Steel Body 1/8 End Fittings (A)
E2811	Nafion Dryer Stainless Steel Body 1/16 End Fittings (A)
E2812	Nafion Dryer Fluoropolymer Body 1/8 End Fittings (A)
E2813	Nafion Dryer Polypropylene Body 1/8 End Fittings (A)
	Replacement inner element
E2820	12" long, 0.05" Tubing, Polypropylene Flanged End Pieces
E2821	12" long, 0.05" Tubing, Fluoropolymer Flanged End Pieces
E2822	12" long, 0.05" Tubing, Stainless Steel Flanged End Pieces

Nafion® is a registered trademark of E.I. DuPont.

	Cat No	Description	Pack
	Exetainer® 4.5ml borosilicate vial, round bottom, 46x15.5mm		
	E2830	Non-evacuated, unlabelled, seal + white cap	1000
	E2831	Evacuated, unlabelled, seal + white cap	1000
	E2832	Non-evacuated, labelled, seal + white cap	1000
	E2833	Evacuated, labelled, seal + white cap	1000
	E2834	Non-evacuated, unlabelled, seal + white cap	2000
	Exetainer® 5.9ml soda glass vial, flat bottom, 55x15.5mm		
	E2840	Non-evacuated, unlabelled, seal + white cap	1000
	E2841	Evacuated, unlabelled, seal + white cap	1000
	E2842	Non-evacuated, labelled, seal + white cap	1000
	E2843	Evacuated, labelled, seal + white cap	1000
	Exetainer® 12ml soda glass vial, flat bottom, 101x15.5mm		
	E2850	Non-evacuated, unlabelled, seal + white cap	1000
	E2851	Evacuated, unlabelled, seal + white cap	1000
	E2852	Non-evacuated, labelled, seal + white cap	1000
	E2853	Evacuated, labelled, seal + white cap	1000
	E2869	Evacuated, labelled, double wadded, white cap	1000
	Exetainer® 12ml borosilicate vial, round bottom, 101x15.5mm		
	E2860	Non-evacuated, unlabelled, seal + white cap	1000
	E2861	Evacuated, unlabelled, seal + white cap	1000
	E2862	Non-evacuated, labelled, seal + white cap	1000
	E2863	Evacuated, labelled, seal + white cap	1000
	E2868	Non-evacuated, labelled, double wadded white cap	500
	Exetainer® 12ml soda glass vial, flat bottom, 101x15.5mm silicone coated for ¹³C breath test		
	E2870	Non-evacuated, unlabelled, seal+white cap	1000
	E2871	Evacuated, unlabelled, seal+white cap	1000
	E2872	Non-evacuated, labelled, seal+white cap	1000
	E2873	Evacuated, labelled, seal+white cap	1000
	Exetainer® 12ml borosilicate vial, round bottom, 104x15.5mm (Wide thread)		
	<i>The wide thread profile of these Exetainer® vials gives a very tight screw fit, and is designed to avoid any cap movement when samples are heated - e.g. on a gas bench.</i>		
	E2864	Non-evacuated, unlabelled, seal + white cap	1000
	E2881	Evacuated, unlabelled, seal + white cap.	1000
	E2882	Non-evacuated, labelled, seal + white cap	1000
	E2883	Evacuated, labelled, seal + white cap	1000
	E2867	Non-evacuated, unlabelled, seal + white cap, 500 vials + 1000 spare caps	500 & 1000
	E2884	Non-evacuated, labelled, seal + white cap, 500 vials + 1000 spare caps	500 & 1000
Exetainer® septa and caps			
E2865	Septa VW101	1000	
E2866	Pierceable caps Blue VC301	1000	
E2885	Pierceable caps white VC309	1000	
E2886	Pierceable caps Orange VC306	1000	
E2887	Pierceable caps Grey VC303	1000	

Exetainer® is a registered trademark of Labco Ltd.

Reference materials

CF-IRMS analysis



Isotope reference materials

Cat No	Description	Pack	$\delta^{13}\text{C}$ ‰	$\delta^2\text{H}$ ‰	$\delta^{15}\text{N}$ ‰	$\delta^{18}\text{O}$ ‰	$\delta^{34}\text{S}$ ‰
Interlaboratory comparison Certified Isotopic Reference Materials ¹							
B2203	IRMS Certified Reference Material EMAP1	3g	-27.85	-25.30		20.99	-3.01
B2205	IRMS Certified Reference Material EMAP2	3g	-28.19	-87.80	-1.57	26.88	
B2207	Silver phosphate (Ag ₃ PO ₄) 18O IRMS Standard	1g				21.7	
B2214	Carrara marble powder IRMS standard for 13C & 18O	0.5g	2.10			-2.01	
Certified Isotopic Reference Materials ²							
B2151	High Organic Content Sediment IRMS Standard OAS/Isotope	5g	-28.85		4.32		
B2153	Low Organic Content Soil IRMS Standard OAS/Isotope	5g	-22.88		5.78		
B2155	Protein IRMS Standard OAS/Isotope	5g	-26.98		5.83		6.18 *
B2157	Wheat Flour IRMS Standard OAS/Isotope	5g	-27.21		2.73		-2.38 *
B2159	Sorghum Flour IRMS Standard OAS/Isotope	5g	-13.78		1.58		10.11 *
B2215	Gelatin IRMS standard certified for 13C 15N 18O 34S	2g	-22.92		4.26	6.76	1.21
Uncertified working standards ³							
B2190	2H and 18O isotope IRMS standard High enriched water	25ml		1701.83		266.83	
B2191	2H and 18O isotope IRMS standard Medium enriched water	25ml		843.43		108.63	
B2192	2H and 18O isotope IRMS standard Zero natural water	25ml		11.26		-0.41	
B2193	2H and 18O isotope IRMS standard Medium natural water	25ml		-98.32		-12.34	
B2194	2H and 18O isotope IRMS standard Low natural water	25ml		-269.07		-33.57	
B2195	2H and 18O isotope standard Set of 5 water working standards	5 x 25ml					
B2172	Olive Oil Isotopic Working IRMS Standard (13C)	5g	-29.32				
B2174	Urea Isotopic Working IRMS Standard (13C, 15N)	5g	-36.54		-2.35		
B2213	Spruce powder IRMS standard for 15N, 13C & 18O	3g	-25.44		-4.9	23.59	

Notes

1. Interlaboratory comparison Certified Isotopic Reference Materials - Certified through an international study involving 6 to 25 laboratories.
2. Certified Isotopic Reference Materials - Derived from data from two or more instruments in a single testing organisation on two or more runs on different days.
3. Uncertified working standards - Using data from a single instrument and intended as "in-run" reference only.

* Values not certified; given for information only.

Analysis values may change depending on the current batch available; please see the website or contact us for information on the current analysis values of reference materials.

Europa

N/N&C determination

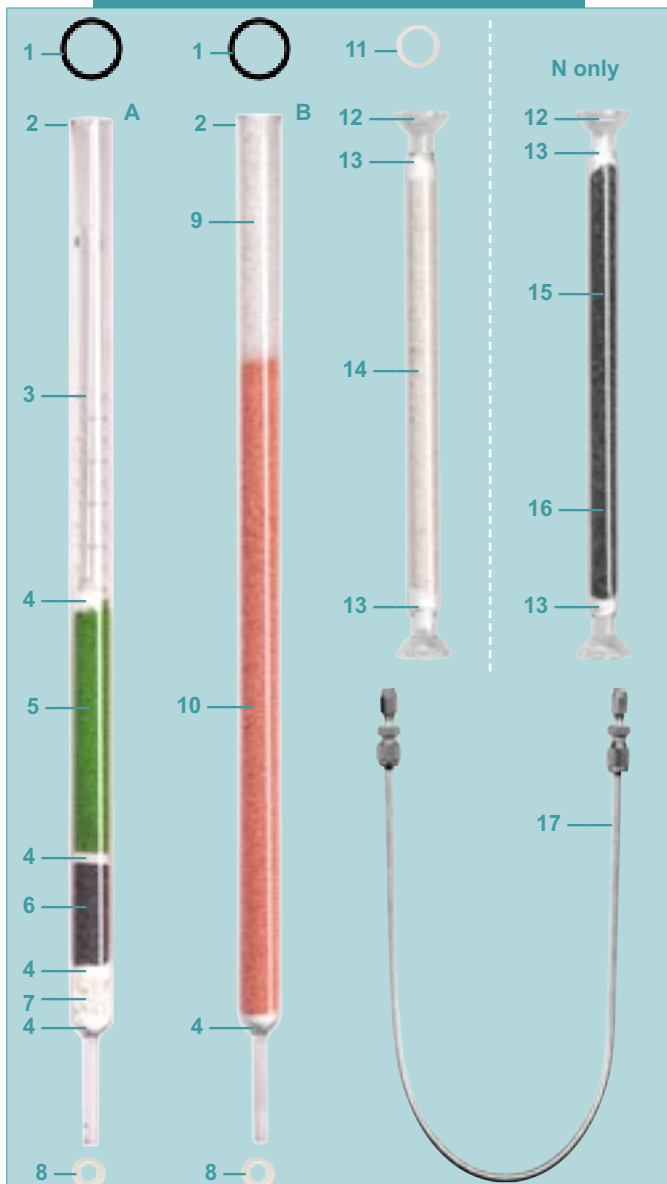

Product	Qty	Europa no.	Cat no.
1 O-ring, upper, nitrile rubber			E1004
2 Reaction tube, transparent silica		C1001012	C1040
3 Sleeve insert		C1001048	C1050
4 Quartz wool, very fine	5 mm	C1001016	B1208
5 Chromium oxide	110 mm	C1001004	B1004
6 Copper oxide fine wires	40 mm	C1001007	B1002
7 Silver wool, very fine	20 mm	C1001018	B1119
8 O-ring, lower		E1005669	E1420
9 Quartz chips	100 mm	C1001017	B1008
10 Copper wires, fine	320 mm	C1001006	B1015
11 O-ring		E1002684	E1421
12 Scrubbing tube		E1002687	C1063
13 Quartz wool, very fine	10 mm	C1001016	B1208
14 Magnesium perchlorate		C1001008	B1101
15 EMASorb B granular 1.6 to 3mm	½ tube		B1118
16 EMASorb A granular 0.8 to 1.6mm	½ tube		B1116
17 Separation Column NC 0.5m		E1004907	E3031
A Prepacked reaction tube (includes C1050 quartz liner)			X1200
Prepacked reaction tube, heavy wall, (includes C1050 quartz liner)			X1201
B Prepacked reduction tube			X1203
Prepacked reduction tube, heavy wall,			X1204

Europa

S determination

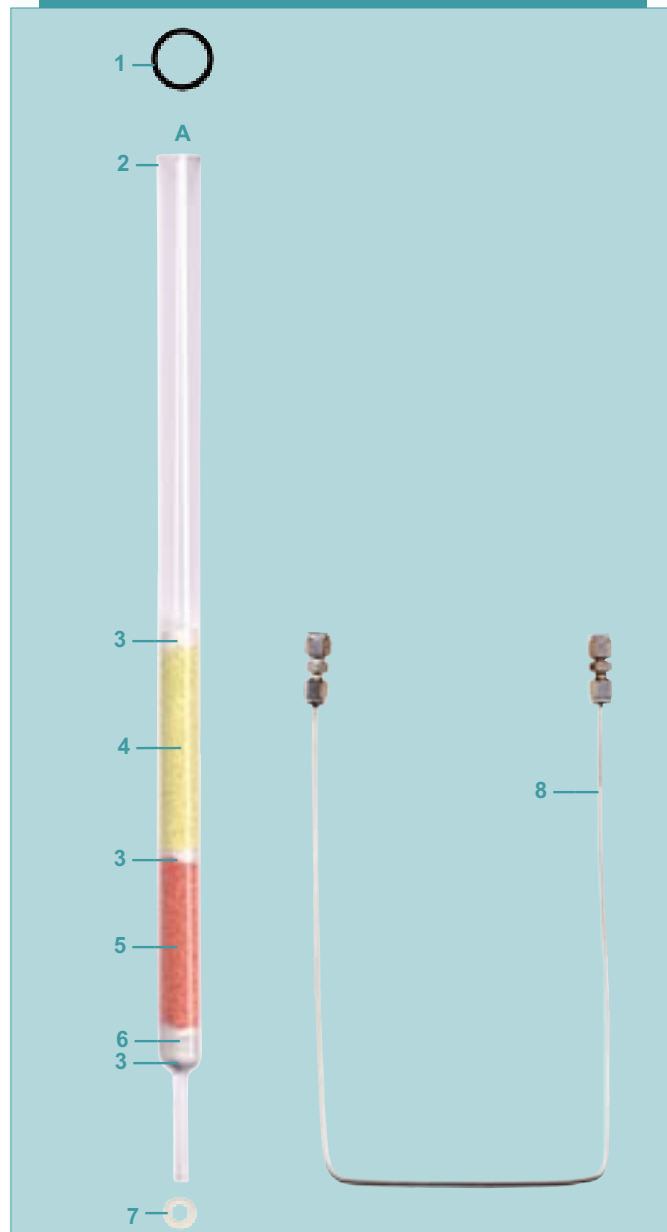

Product	Qty	Europa no.	Cat no.
1 O-ring, upper, nitrile rubber			E1004
2 Reaction tube, transparent silica		C1001012	C1040
3 Quartz wool, very fine	5 mm	C1001016	B1208
4 Tungstic oxide/zirconium oxide	90 mm		B1082
5 Copper wires, high purity	80 mm	C1001042	B1035
6 Quartz chips	10 mm	C1001017	B1008
7 O-ring, lower		E1005669	E1420
8 Separation column sulphur 0.6m			E3032
A Prepacked reaction/reduction tube			X1205

Europa

O pyrolysis

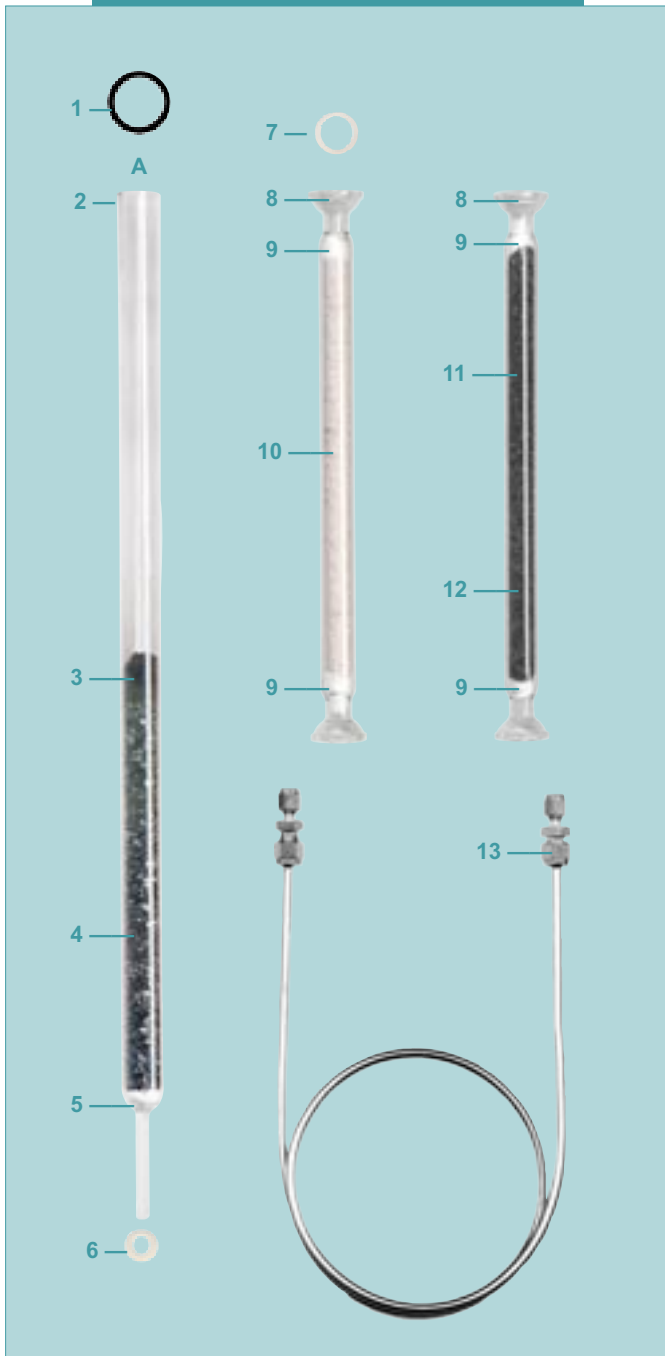

Key				
Product	Qty	Europa no.	Cat no.	
1 O-ring, upper, nitrile rubber			E1004	
2 Reaction tube, transparent silica		C1001012	C1040	
3 Nickelised carbon 50% Ni	10 mm		B1182	
4 Glassy carbon chips 2-3mm	180 mm	C1001071	C7003	
5 Quartz wool, very fine	5 mm	C1001016	B1208	
6 O-ring, lower		E1005669	E1420	
7 O-ring		E1002684	E1421	
8 Scrubbing tube		E1002687	C1063	
9 Quartz wool, very fine	10 mm	C1001016	B1208	
10 Magnesium perchlorate		C1001008	B1101	
11 EMASorb B granular 1.6 to 3mm	½ tube		B1118	
12 EMASorb A granular 0.8 to 1.6mm	½ tube		B1116	
13 Separation Column Oxygen 1m			E3030	
A Prepacked oxygen pyrolysis tube			X1207	

Europa

H pyrolysis

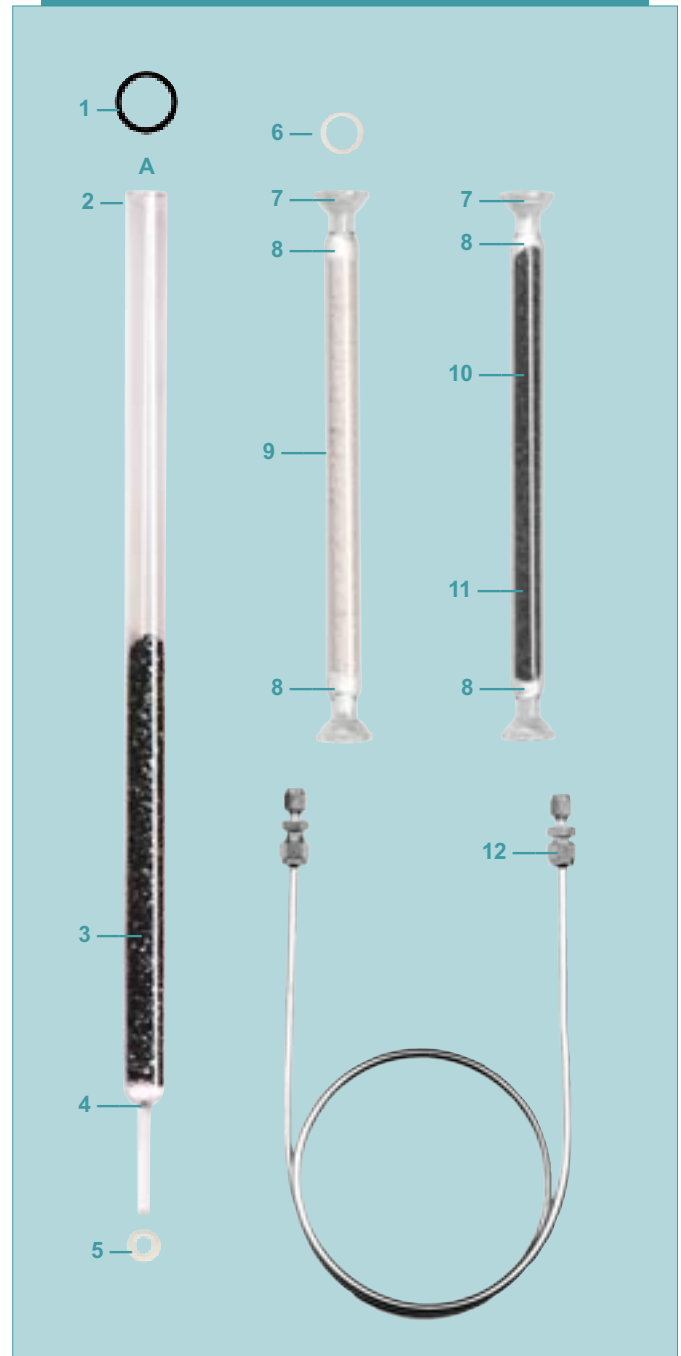

Key				
Product	Qty	Europa no.	Cat no.	
1 O-ring, upper, nitrile rubber			E1004	
2 Reaction tube, transparent silica		C1001012	C1040	
3 Glassy carbon chips 2-3mm	180 mm	C1001071	C7003	
4 Quartz wool, very fine	5 mm	C1001016	B1208	
5 O-ring, lower		E1005669	E1420	
6 O-ring		E1002684	E1421	
7 Scrubbing tube		E1002687	C1063	
8 Quartz wool, very fine	10 mm	C1001016	B1208	
9 Magnesium perchlorate		C1001008	B1101	
10 EMASorb B granular 1.6 to 3mm	½ tube		B1118	
11 EMASorb A granular 0.8 to 1.6mm	½ tube		B1116	
12 Separation Column Oxygen 1m			E3030	
A Prepacked hydrogen pyrolysis tube			X1209	

Europa Roboprep

CN determination

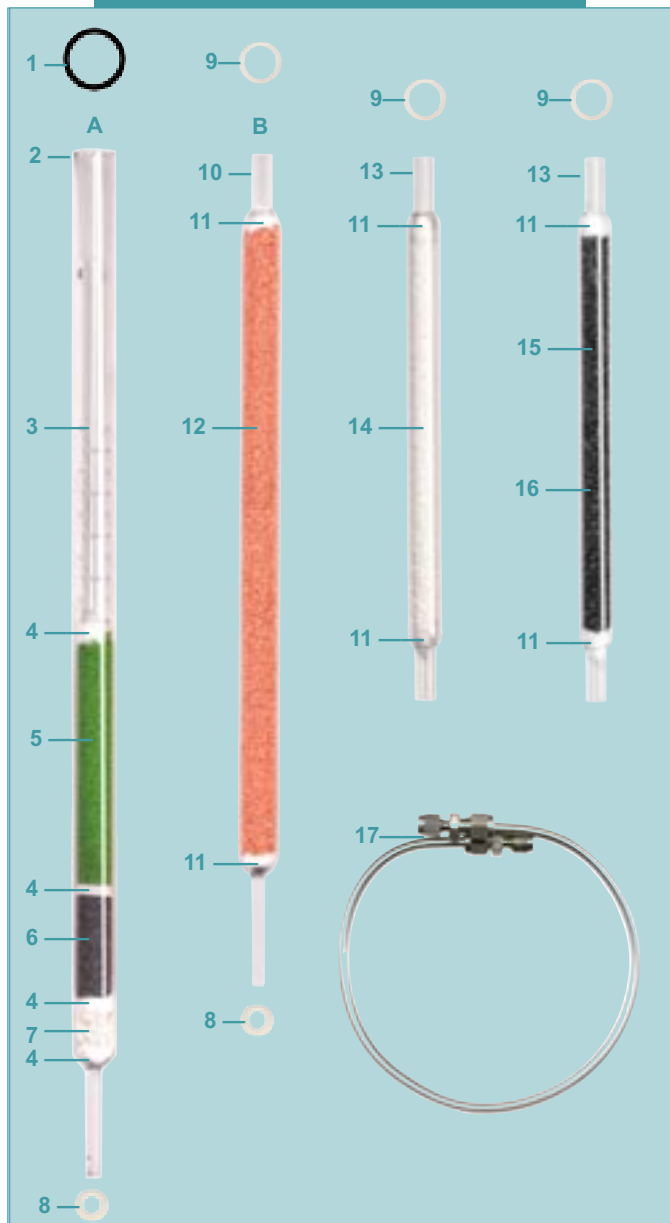

Key			
Product	Qty	Europa no.	Cat no.
1 O-ring, upper, nitrile rubber			E1004
2 Reaction tube, transparent silica		C1001012	C1040
3 Sleeve insert		C1001048	C1050
4 Quartz wool, very fine	5 mm	C1001016	B1208
5 Chromium oxide	110 mm	C1001004	B1004
6 Copper oxide fine wires	40 mm	C1001007	B1002
7 Silver wool, very fine	20 mm	C1001018	B1119
8 O-ring, lower		E1005669	E1420
9 O-ring		E1002684	E1421
10 Reduction tube		C1001014	C1030
11 Quartz wool, very fine	10 mm	C1001016	B1208
12 Copper wires, fine	320 mm	C1001006	B1015
13 Scrubber tube		C1001015	C1032
14 Magnesium perchlorate		C1001008	B1101
15 EMASorb B granular 1.6 to 3mm	½ tube		B1118
16 EMASorb A granular 0.8 to 1.6mm	½ tube		B1116
17 Separation column NC 0.5m			E3033
A Prepacked reaction tube (includes C1050 quartz liner)			X1200
B Prepacked reduction tube			X1202

Elementar vario PYRO cube

H/H-O/O pyrolysis

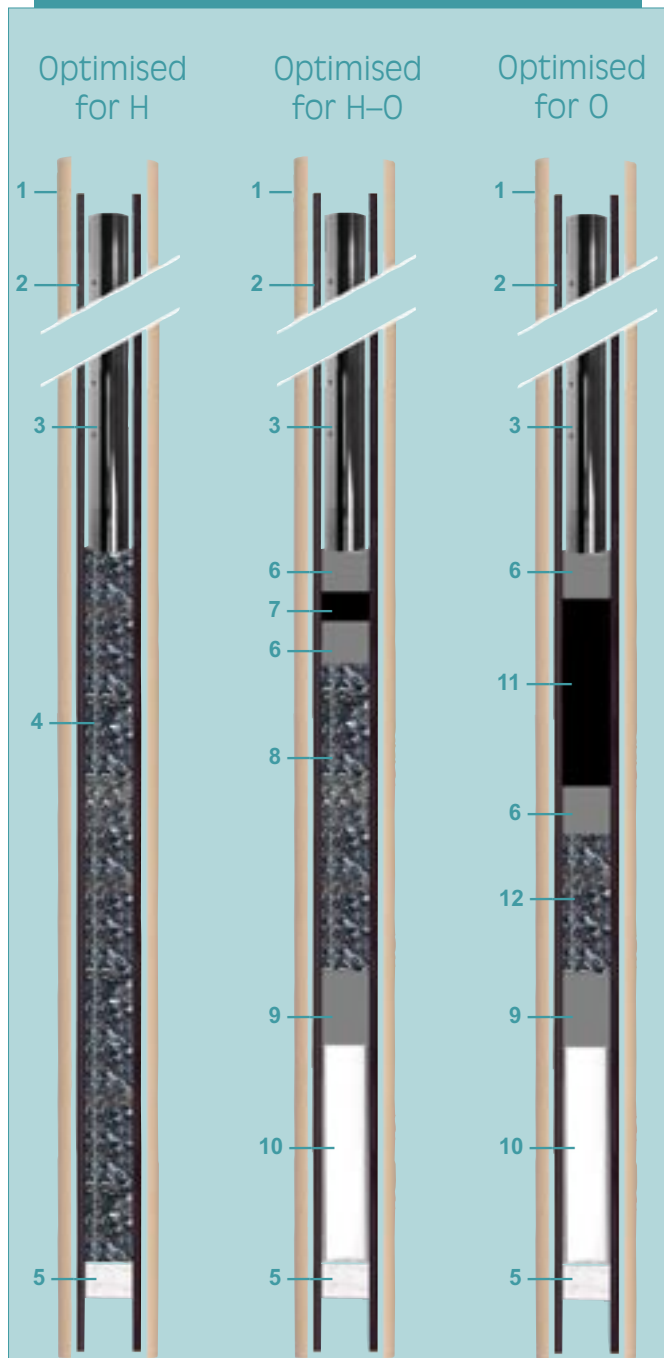

Key			
Product	Qty	Elementar no.	Cat no.
1 Ceramic outer tube		23.00-1021	C1106
2 Glassy carbon tube		23.00-1020	C7017
3 Ash finger, glassy carbon		15.00-1189	C7018
3 (alternative) Ash crucible, graphite		23.00-1189	C3061
4 Glassy carbon chips	195 mm	11.64-0050	C7021
5 Quartz wool	10 mm	03 679 908	B1208
6 Graphite felt (one layer)			
7 Carbon black	8 mm		
8 Glassy carbon chips	85 mm	11.64-0050	C7021
9 Graphite felt (two layers)			
10 Support tube 60mm		15.00-1119	
11 Carbon black	50 mm		
12 Glassy carbon chips	35 mm	11.64-0050	C7021

Eurovector EA-3028HT

High temperature pyrolysis

Oxygen analysis

Hydrogen analysis

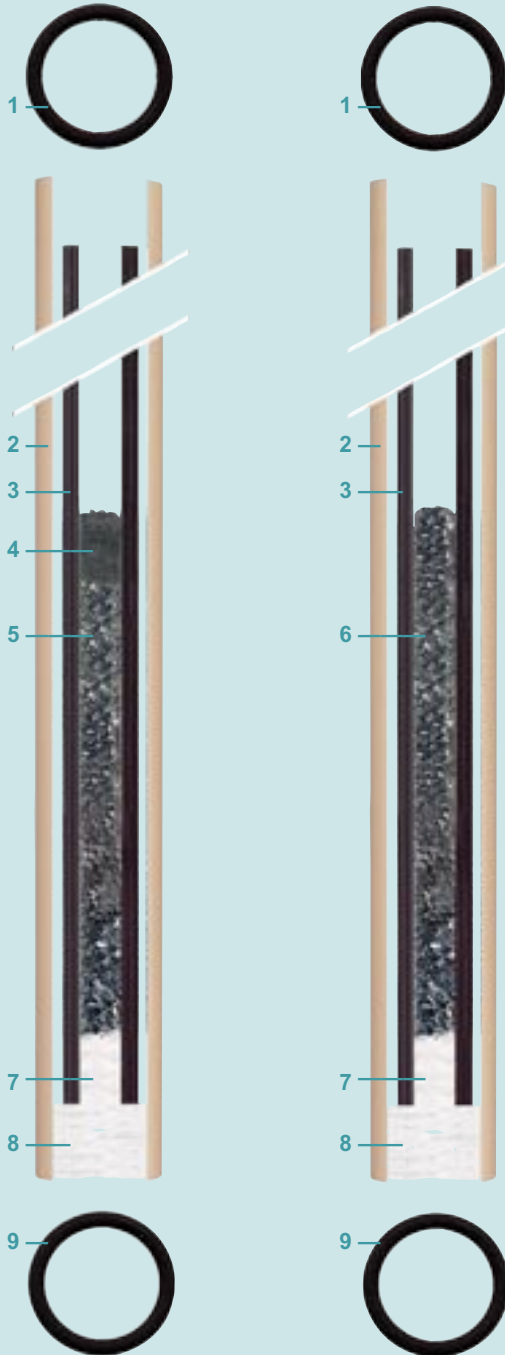

Key

Product	Qty	Eurovector no.	Cat no.
1 O-ring for ceramic reactor 17mm		E13538	E1506
2 Ceramic tube		E12507	C1102
3 Glassy carbon tube		E12529	C7004
4 Nickelised carbon	20 mm	E10145	B1182
5 Glassy carbon chips	120 mm	E10521	C7003
6 Glassy carbon chips	140 mm	E10521	C7003
7 Silica (quartz) wool, very fine	20 mm	E10514	B1017
8 Silica (quartz) wool, very fine	20 mm	E10514	B1017
9 O-ring for bottom, quick fit, 17mm		E13539	E1507
10 Separation column O/H 1.5m		E11521	E3036

Eurovector EA-3028HT

H in liquids using chrome catalyst

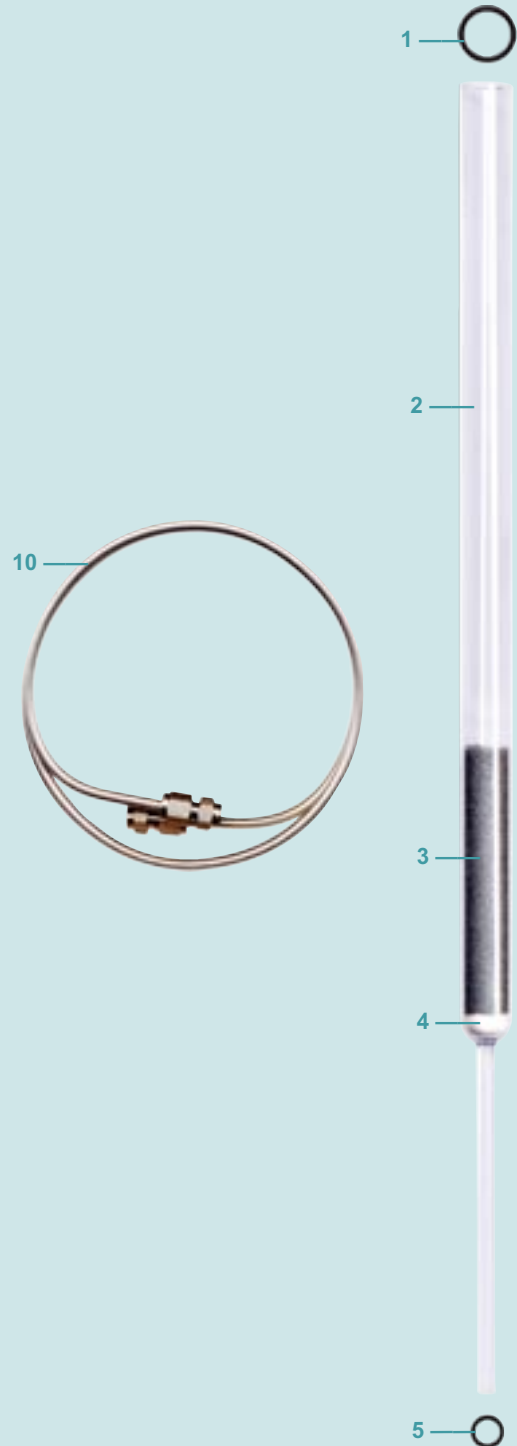

Key

Product	Qty	Eurovector no.	Cat no.
1 O-ring for reactor 18mm od		E13536	E1504
2 Reaction Tube Modified Transparent silica		E12512	C1056
3 Chrome Catalyst	90 mm	E10103	B1450
4 Silica (Quartz) Wool Very Fine	10 mm	E10514	B1017
5 O-ring viton bottom quick fit 6mm		E13540	E1508
10 Separation column O/H 1.5m		E11521	E3036

Hekatech HT-O

High temperature pyrolysis

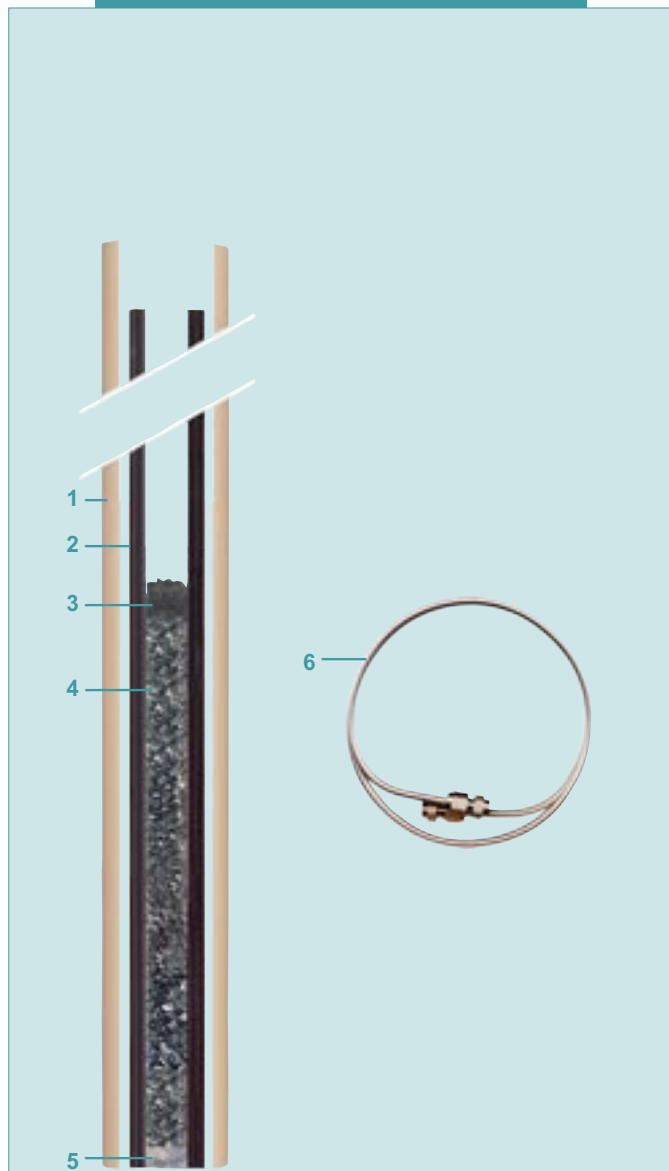

Key			
Product	Qty	Hekatech no.	Cat no.
1 Ceramic tube		HE 468110	C1103
2 Glassy carbon tube		HE 46860100	C7004
3 Nickelised carbon	10 mm	HE 33823800	B1182
4 Glassy carbon chips	135 mm	HE 33823850	C7003
5 Nickel wool, fine wire	5 mm	HE 3382500	B1007
6 Separation column oxygen 1m		HE 26007900	E3001

Thermo TC/EA

High temperature pyrolysis

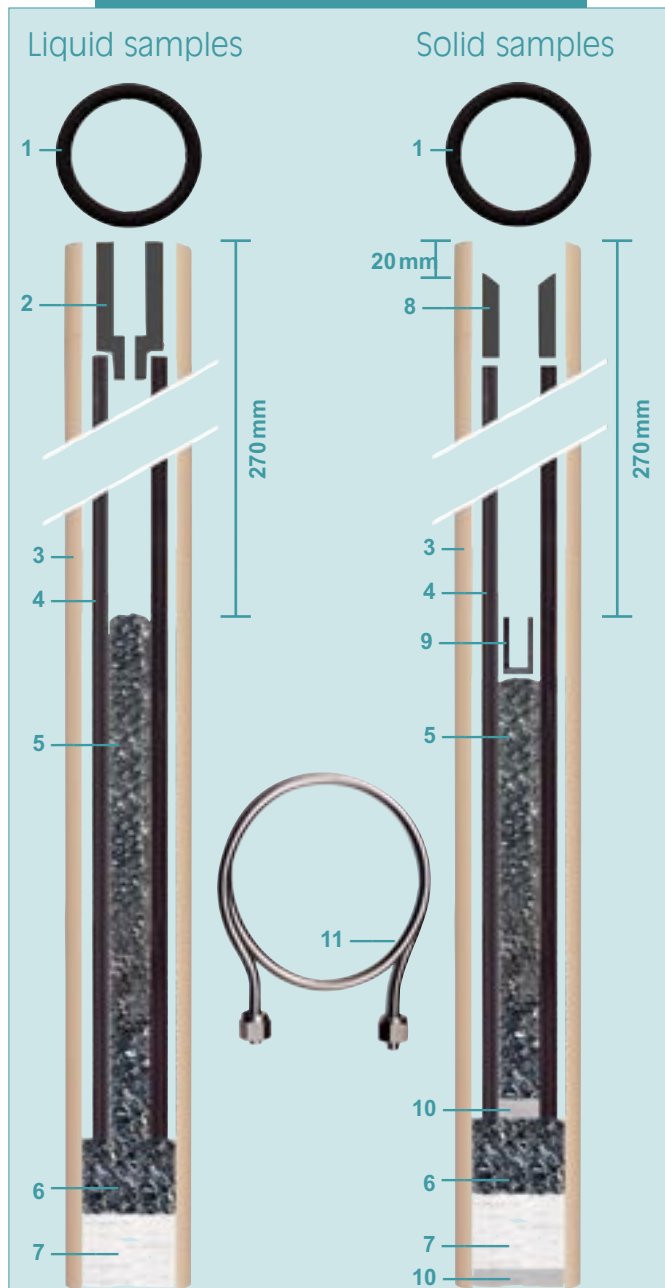

Key			
Product	Qty	Thermo no.	Cat no.
1 O-ring		1121120	E6053
2 Graphite tube		1132080	C7011
3 Ceramic tube		1121320	C1101
4 Glassy carbon tube		1121310	C7001
5 Glassy carbon chips		1117400	C7002
6 Silica (quartz) wool, very fine	20 mm	33822200	B1017
7 Graphite tube		1121351	C7010
9 Graphite crucible		1117332	C7012
10 Silver wool, very fine	5 mm	1117430	B1119
11 GC column TC/EA 0.6m		1121030	E3035

Cross references

CF-IRMS analysis

The use of OEM part numbers is intended for convenience only, and does not imply that the products are of OEM origin. All Elemental Microanalysis products are guaranteed to be of high quality and are deemed to be suitable alternatives.

	OEM part	Description	Pack	Cat. No.
Costech	Costech			
	021024	Nickel Wool Fine Wire	2g	B1007
	021026	Silica (Quartz) Wool Very Fine	5g	B1017
	021035	Silica (Quartz) Wool Very Fine	10g	B1208
	021036	Silica (Quartz) Wool Very Fine	10g	B1208
	64001	Reaction Tube Transparent Silica Roboprep - ANCA SL/GSL-Integra		C1040
	64002	Reduction Tube Transparent Silica Roboprep		C1030
64004	Scrubbing Tube Borosilicate		C1063	
Elementar	Elementar			
	03 679 908	Silica (Quartz) Wool Very Fine	10g	B1208
	05 002 321	Oxygen lance 90mm		C3028
	11.00-1364/4	Support rod, reduction tube 65mm		C3053
	11.64-0050	Glassy carbon chips	80g	C7021
	15.00-1189	Ash Finger - High Temperature Pyrocube		C7018
	15.40-1002	Support rod reduction tube 110mm		C3057
	23.00-1020	Glassy Carbon Tube Pyrocube		C7017
	23.00-1021	Ceramic Tube Pyrocube		C1106
	23.00-1148	Support rod reduction tube 175mm		C3052
	23.00-1149	Reduction Tube Pyrocube		C3050
	23.00-1150	Combustion Tube Pyrocube		C3051
	23.00-1189	Ash crucible graphite		C3061
	Europa	Europa		
C1001012		Reaction Tube Transparent Silica Roboprep - ANCA SL/GSL-Integra		C1040
C1001014		Reduction Tube Transparent Silica Roboprep		C1030
C1001015		Scrubber Tube Borosilicate Glass Roboprep		C1032
C1001016		Silica (Quartz) Wool Very Fine	10g	B1208
C1001018		Silver Wool Very Fine Wire Unreeled 89 sqcm/g	10g	B1119
C1001048		Sleeve Insert Open Both Ends Transparent Silica 15 x 180mm Europa		C1050
C1001071		Glassy Carbon Chips Eurovector 2-3mm,	25g	C7003
E1002527		Platinised Copper Oxide 10% Pt Isotope Grade Granular 0.2 to 0.5mm	2g	B1030
E1002684		O Ring Europa		E1421
E1002687		Scrubbing Tube Borosilicate		C1063
E1005669	O Ring Europa		E1420	
Eurovector	Eurovector			
	6062974	Consumable Kit Eurovector EA-Sulphur 1000 analysis		X3252
	6062977	Consumable Kit Eurovector EA-Hydrogen spares for liquid samples (low temperature)		X3253
	6062978	Consumable Kit Eurovector EA-Oxygen spares for liquid samples		X3254
	6062979	Consumable Kit Eurovector EA-O/H solid samples (high temperature)		X3251
	6063056	Consumable Kit Eurovector EA-CN 1000 analysis		X3250
	C10-017	Silica (Quartz) Wool Very Fine	5g	B1017
	E10103	Chrome Catalyst	100g	B1450
	E10145	Nickelised Carbon 50% Ni Granular 0.85 to 1.7mm	5g	B1182
	E10146	Nickelised Carbon 30% Ni Granular 0.3 to 0.85mm	5g	B1086
	E10510	Nickel Wool Fine Wire	2g	B1007
	E10514	Silica (Quartz) Wool Very Fine	5g	B1017
	E10521	Glassy Carbon Chips Eurovector 2-3mm,	25g	C7003
	E11521	Separation column O/H 1.5m stainless steel		E3036
	E11528-IG	Eurovector high resolution column (0.7m) for GC separation of C/N in IRMS work		E3037
	E12507	Ceramic Tube for Eurovector	2	C1102
	E12512	Reaction Tube Transparent silica		C1056
	E12529	Glassy Carbon Tube Eurovector		C7004
	E13502	Small trap with o-rings, threaded caps and fitting (to take 2mm tubing nuts)		E6101
	E13538	O-ring for ceramic reactor 17mm		E1506
	E13539	O-ring EVR for bottom quick fit 17mm		E1507

	OEM part	Description	Pack	Cat. No.
Hekatech	Hekatech			
	HE 468110	Ceramic Tube HT-O		C1103
	HE 33823800	Nickelised Carbon 50% Ni Granular 0.85 to 1.7mm 5g		B1182
	HE 33823850	Glassy Carbon Chips Eurovector 2-3mm,	25g	C7003
	HE 3382500	Nickel Wool Fine Wire	2g	B1007
	HE 46860100	Glassy Carbon Tube Eurovector		C7004
Thermo	Thermo			
	0605470	Capillary SS 1/16 x 0.8 mm, 2m		F5170
	1040820	Prepacked GC reduction reactor tube 320x1.5x0.5mm Ceramic Copper Wire		X1506
	1040920	Prepacked GC oxidation reactor tube 320x1.5x0.5mm Ceramic, Copper/Platinum/Nickel Wire		X1505
	1117332	Graphite Crucible for TC/EA		C7012
	1117400	Glassy Carbon Chips Thermo-Finnigan TC/EA 3-4mm	25g	C7002
	1117401	Glassy Carbon Chips Thermo-Finnigan TC/EA	50g	C7015
	1117430	Silver Wool Very Fine Wire Unreeled 89 sqcm/g	2g	B1261
	1121030	GC Column TC/EA 0.6m 1/4 Stainless Steel		E3035
	1121120	O Ring TC/EA		E6053
	1121310	Glassy Carbon Tube Thermo-Finnigan TC/EA		C7001
	1121320	Ceramic Tube for TC/EA		C1101
	1121351	TC/EA Graphite Tube		C7010
	1127500	Prepacked TC/EA Tube (ceramic and glassy carbon)		X7020
	1132080	H2O Graphite Tube for TC/EA		C7011
	1136820	Spare Parts/Consumables TC/EA, OH Analysis (3000 Analyses)		X1136
	1141050	Reactor Kit TC/EA		X7007
	1185471	Spare parts/consumables for Flash 2000 HT & EA IsoLink CN/OH, OH analysis (3000 analyses) 1185471		X1137
	1197480	Reactor kit Flash HT		X7008
	129 3150	NC 1000 an. Kit Flash IRMS		X1115
	1290340	Consumables Flash HT and TC/EA, OH-Analysis (1000 Analyses)		X1138
	19003770	NC 1000 an. Kit Flash IRMS		X1115
	26007931	NC separation column for IRMS		E3011
	28113102	Small trap with o-rings, threaded caps and fitting (to take 2mm tubing nuts)		E6101
	29000063	O Ring pack of 2 for E4405		E6054
	29030042	O Ring Nitrile Rubber	10	E1004
	29030042	Seal Viton Rubber Chamfered Square Profile	5	E1042
	29030331	O Ring Viton Rubber	10	E1001
	33822200	Silica (Quartz) Wool Very Fine	5g	B1017
	33822205	Silica (Quartz) Wool Very Fine	15 g	B1276
	33823800	Nickelised Carbon 30% Ni Granular 0.3 to 0.85mm	5g	B1086
	33825000	Nickel Wool Fine Wire	2g	B1007
46802021	Pre-packed Ox/Red Reactor NCS DET. for Flash HT Plus (Argon sealed)		X1172	

The use of OEM part numbers is intended for convenience only, and does not imply that the products are of OEM origin. All Elemental Microanalysis products are guaranteed to be of high quality and are deemed to be suitable alternatives.

Products from Elemental Microanalysis

Operating from Devon UK, our business holds three separate accreditations: ISO 9001 for our huge product range, supplying customers worldwide with high quality analytical consumables at value prices; ISO 17025 for our analytical services laboratory; and ISO 17034 for our new range of certified standards. Our qualified despatch and sales teams can organise safe, speedy and economical shipment of your orders worldwide by air, road or sea.

	SAMPLE ENCAPSULATION	GLASSWARE AND FURNACE TUBES	CHEMICAL REAGENTS	REFERENCE MATERIALS	OTHER PARTS AND CONSUMABLES
CHNOS (MICRO) ANALYSIS					
NITROGEN/PROTEIN DUMAS ANALYSIS					
INORGANIC ANALYSIS					
ORGANIC CARBON/SULPHUR ANALYSIS					
MACRO CHN CNS ANALYSIS					
EA-IRMS ANALYSIS					
TRACE NITROGEN, SULPHUR AND TOC ANALYSIS					

These pictures show only a small fraction of the thousands of products we have available for combustion elemental analysis.

For further information please request our catalogue for the application area you are interested in; we can also provide analyser specific consumables lists.

Elemental Microanalysis – a global company

Our quality products are sold world-wide, via our network of Dealers and through direct sales.



■ Current sales areas world-wide

What our Quality Accreditations mean for you



Our Dealers and customers know they are receiving quality, reliable products when they work with Elemental Microanalysis. Our company's quality system is certified to BS EN ISO 9001:2015 by LRQA; we have an ISO/IEC 17025:2017 UKAS Accredited Laboratory; and we are an ISO/IEC 17034:2016 UKAS accredited Reference Material Producer.



Our accredited products, services and systems are frequently reviewed as part of external quality assessment. Our quality management team are dedicated to ensuring you receive the best products and services, giving you confidence and peace of mind.



Consistency is critical for laboratory accuracy. Here at Elemental Microanalysis, we offer excellence in both materials and staff, providing a reassuring, reliable and consistent choice for your business.

'reliable and consistent'

Our staff is invested in your success and ready to support Dealers, analytical laboratories and other customers in meeting the demands of modern research.

'Confidence and peace of mind'

Resources for Dealers

Elemental Microanalysis provides many resources to support for our dealer network

- Catalogues
- Product sheets for individual analysers
- Safety data sheets (SDS)
- Informational sales tools such as product cross reference lists, promotional communications and tables of reference material values.
- Promotional product images

All these resources are available for download via our Dealers Sharepoint – please enquire for access. We can also provide materials for Exhibitions and Trade Shows.

Analysis Service



Our analytical services cover a diverse range of sample types and applications, performed by a laboratory with over 40 years of accumulated analytical expertise.

We can perform organic (C H N O S, TOC* and nitrogen/protein), inorganic* and stable isotope* elemental determination, and offer specialist capability for air sensitive samples. Our analysis systems are calibrated using NIST traceable reference standards.

* These services are not ISO 17025 accredited.

- Results within 72 hours or under
- UKAS accredited Testing Laboratory No. 4260
- ISO 9001 accredited business

Whether you have a single sample, or an on-going research program, we offer you commitment to precision and accuracy at an affordable price.

LITERATURE REQUEST

Elemental Microanalysis can supply product sheets tailored specifically to your analyser, product catalogues, and various other literature to help you find the products you need. This literature is available in printed or digital format – just tick the boxes, fill out your details and return the form to us or your local dealer. The latest editions of our Catalogues are also available to download from our website: www.elementalmicroanalysis.com

Product sheets available, by analyser:

Inorganic *(Please Tick)*

Bruker G4 Icarus CS	
Bruker G8 Galileo O, N, H	
Eltra CS2000	
Eltra CS800	
Eltra OH900	
Eltra ON900	
Horiba EMGA-620/621	
Horiba EMGA-800/900	
Horiba EMGA-821/921	
Horiba EMIA-320V2/920V2	
Horiba EMIA820V/320V/220V	
Leco 836/736 ONH/OH/NH/H	
Leco CS125/255	
Leco CS200/C200/S200/WC200	
Leco CS230	
Leco CS244/344/IR212/232	
Leco CS300	
Leco CS400/C400/S400	
Leco CS444/IR412/432	
Leco CS600	
Leco CS744/844	
Leco DH102/103/RH101	
Leco DH603	
Leco RH402	
Leco RH404	
Leco RHEN602	
Leco RO478	
Leco TC136/336/TN114/RO116	
Leco TC300/RO300/TN300	
Leco TC436/TN414/RO416	
Leco TC500/600	
Leco TCH600	
Leco WR112	
Strohlein/Juwe NH-mat 243	

All trademarks acknowledged. Use of the OEM part number is for reference only and does not imply that the products are of OEM origin. All Elemental Products are guaranteed to be of high quality and suitable for use in the stated application.

Micro/CHN(OS) *(Please Tick)*

Costech ECS4010	
Elementar CHN Rapid	
Elementar Pyro Cube	
Elementar Vario Micro Cube	
Elementar Vario EL	
Elementar Vario EL Cube	
Elementar Vario Isotope Cube	
Europa Roboprep/ANCA/Integra	
Eurovector EA3000	
Eurovector EA3100	
Eurovector EA-3028HT	
Exeter CE240/440	
Hekatech HT-O	
Leco 900/932	
Leco Truspec Micro	
Perkin Elmer 2400	
Perkin Elmer 240ABC	
Picarro CM Model 02	
SerCon GSL/Integra	
Thermo EA1106CHNSO	
Thermo EA1108CHNSO	
Thermo EA1110CHNSO	
Thermo EA1112CHNSO/FLASH2000	
Thermo Flash 2000 IRMS	
Thermo Flash HT/HT Plus	
Thermo Flash Smart CHNOS	
Thermo NA1500NCS2	
Thermo TC/EA	
Thermo NA2500NCS	

Macro CHN/CNS *(Please Tick)*

Elementar rapid CS cube	
Elementar Vario Macro	
Elementar Vario Macro cube	
Elementar Vario Max CHN/CNS	
Elementar Vario Max Cube N/CN	
Elementar Vario Max N/CN	
Leco CHN1000/CNS1000	
Leco CHN2000	
Leco CHN600/800	
Leco CNS/NS/CN2000	
Leco Truspec CHN/CN	
Skalar Primacs	

N/Protein *(Please Tick)*

Buchi DuMaster D-480	
CKIC TCN/CHN 2200	
Costech Turbo N	
Elementar Rapid N®	
Elementar Rapid N Cube®	
Elementar Rapid N exceed®	
Elementar Rapid MAX N exceed®	
Gerhardt Dumatherm®	
Leco 828 series	
Leco FP2000	
Leco FP228	
Leco FP328	
Leco FP428	
Leco FP528	
Leco FP628/CHN628	
Leco FP/CN928 series	
Leco TruMac	
Leco Truspec N	
Perkin Elmer 2410	
Thermo Flash 4000	
Thermo FlashSmart CHNOS/N-Protein	
Thermo NA1112Protein/FLASH2000	
Thermo NA2000/2100	
Velp NDA 701 Dumas Nitrogen Analyser	

Organic Carbon/Sulphur

(Please Tick)

Eltra CHS-580/CHS-580A	
Eltra CS-500	
Eltra Helios	
Eltra SurfaceC-800	
Leco SC632	
Leco SC832 series	
Leco TGA601/701	
Leco RC612	
Leco SC144	
Leco SC32/132/232/CR12	
Leco SC432/444/CR412	
Leco RC412	

Product sheets (*continued*)

Trace (*Please Tick*)

Analytik Jena Multi NC2100-3100	
Analytik Jena Multi EA2000	
Analytik Jena Multi EA3000	
Analytik Jena Multi EA4000	
Analytik Jena Multi EA5000	
Analytik Jena Multi X2000	
Analytik Jena Multi X2500	
Analytik Jena Pharma TOC	
Antek 7000 from PAC	
Antek 9000 from PAC	
Antek MultiTek analyser from PAC	
Dohrmann DC	
Dohrmann DN	
Dohrmann MCTS	
Dohrmann DX	
Elementar LiquiTOC	
Elementar trace SN cube	
Elementar Vario TOC Cube	
Elementar Vario Trace S	
Hach IL550 TOC-TN analyser	
Metrohm 930 Combustion IC PP	
Shimadzu TOC	
TE Instruments	
Thermo Euroglas All Instruments	
TSHR Instruments	

Other literature available:

Catalogues (*Please Tick*)

Capsules	
Inorganic	
IRMS Supplement	
Laboratory Analysis Service	
Macro CHN/CNS (including configuration guide)	
Micro/CHN (OS)	
Nitrogen / Protein	
Organic Carbon / Sulphur	

Reference materials/Standards for EA

Pure chemical standards	
Natural materials	
Inorganic materials	
Isotope reference materials	

Ion Chromatography (*Please Tick*)

Dionex AS40/ADSV/ASAP/AS50/AS IC vials	
Metrohm Peak IC Autosampler IC vials	

Can't find what you are looking for? Let us see if we can help: info@microanalysis.co.uk or **+44 (0)183754446**

What format would you like your literature in?
(*Please circle*)

Print

Digital

Name

Organisation

Address

Tel

Email

Post, Fax or Email to:
Elemental Microanalysis Ltd
1 Hameldown Road
Okehampton, Devon
EX20 1UB UK
F: +44 (0)1837 54544
info@microanalysis.co.uk

Or Your Local Dealer:



www.elementalmicroanalysis.com

Visit our website for up-to-date information, news,
product releases and to subscribe to our mailing list.



Elemental Microanalysis Ltd.
Hameldown Road
Okehampton Business Park
Okehampton
Devon EX20 1UB
United Kingdom
Tel: +44 (0)1837 54446
Fax: +44 (0)1837 54544
Email: info@microanalysis.co.uk



www.elementalmicroanalysis.com
www.elementallab.co.uk